



VANTIJ™ Single-Use Virus Filtration Controller

Simply reliable and flexible virus filtration

Built For You.

Asahi Kasei Bioprocess is dedicated to unlocking efficiencies and driving productivity within your biopharmaceutical and plasma derivative virus filtration processes. We also understand that the adaptability and reduced capital expense afforded by single-use systems are preferred in many facilities.

Viral safety is a fundamental regulatory requirement to produce mammalian cell-based or plasma-based protein therapeutics.

By uniting single-use technology with our viral safety know-how, we can help you achieve peace of mind through the implementation of our tried-and-true Planova 15N, 20N, 35N or BioEX filters in a relatively simple and flexible manner.



Compatible with Planova 15N, 20N, 35N and BioEX 1.0 m² or 4.0 m² (see page 8 for details)





Single-Use Means Flexibility & Reliability

In today's clinical and multi-product manufacturing facilities, having flexibility for fast changeover is paramount. To meet these demands, Asahi Kasei Bioprocess has pushed its virus filtration innovations even further into single-use formats that will deliver increased:

1 Product Safety

- » Dramatic reduction in product cross-contamination risk
- » Automated system mitigates risk of operator error

2 Efficiency and Flexibility

- » Product/batch changeover time eliminated, resulting in greater capacity
- » Versatile equipment can be used for multiple products
- » Reduced water consumption (no cleaning)

3 Operational Cost Savings

- » Lower initial investment in capital equipment
- » Eliminating costs of sterilization and cleaning, planning, validation and execution
- » Reduced maintenance

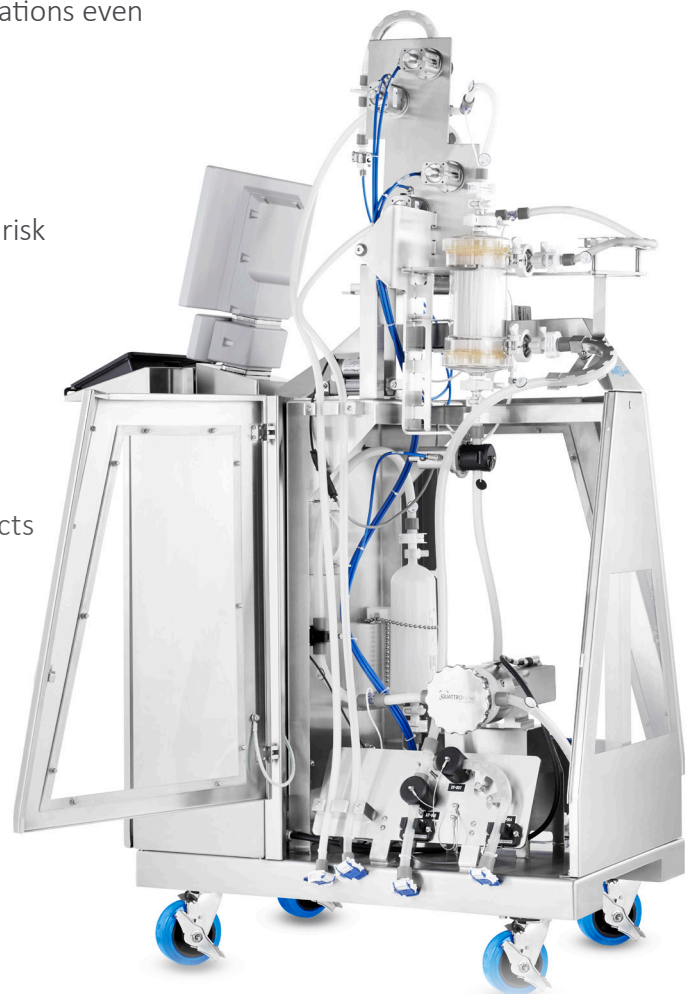

Bold Design, Simple Functionality

With a footprint of a modest 610 mm x 1219 mm (24 in. x 48 in.), the Planova SU-VFC can be installed in almost any downstream processing area and is fully 21 CFR Part 11 compliant. Universal gamma-irradiated tubing sets can be used with our 15N, 20N, 35N and BioEX Planova filters. By incorporating the capability to perform integrity testing, the Planova SU-VFC permits simplified implementation of Planova filters in your process.

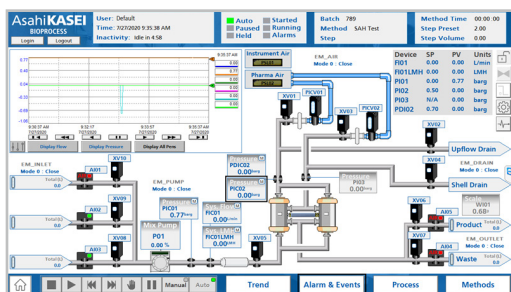

Process Control Screen

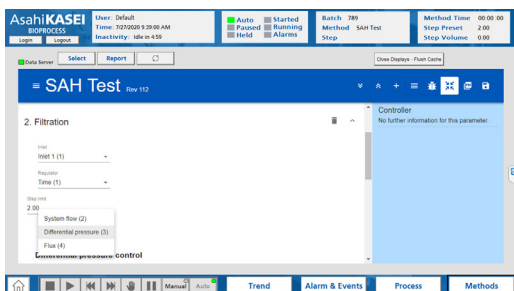

Filtration Selection Screen

Sample Operational Steps

- » System integrity test prior to operation
- » Deaeration
- » WFI flush
- » Optional pre-use visual leakage test
- » Optional flowmeter and pressure transmitter calibration
- » Product filtration
- » Filtration rinse
- » Filter wash
- » Optional post-use visual leakage test
- » Alarms and interlocks also included
- » Filter wash by EQ buffer

Engineered to accommodate your single-use bags – across a wide spectrum of batch sizes – the Planova™ SU-VFC helps you run your viral clearance step in a safe and efficient manner, today and in the future.

Mitigate Risk with Intuitive, Customized Automation

The Planova™ SU-VFC includes several risk-mitigating features and design elements to ensure that your high-value biotherapeutic is safely, reproducibly and reliably filtered batch after batch – including our automation platform that allows for intuitive configuration of all virus filtration process steps.

Specialized

- » Each system is built to manage your critical process conditions
- » Settings, helper text, and key process parameters can all be customized to create a unique user experience
- » Designed to be simple and straightforward

Seamless Integration

- » OPC-ready architecture plugs into your existing DCS, OPC Server, or Historian for batch monitoring and control
- » Browser-based to allow remote method configuration and review of batches, even while the system is in use

Flexible Yet Repeatable

- » Recipe configuration, report templates, and trend displays allow daily customization of system operations
- » Default parameters, favorite steps, chart presets, and report templates allow for easy repeat use
- » Point-of-use scale up/scale down through Control Parameter functionality

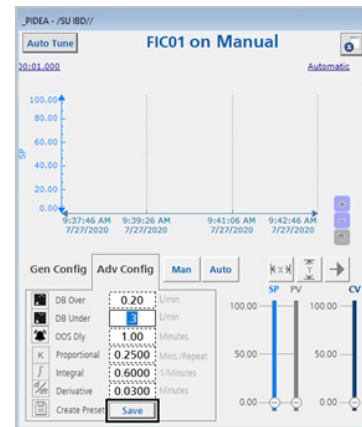
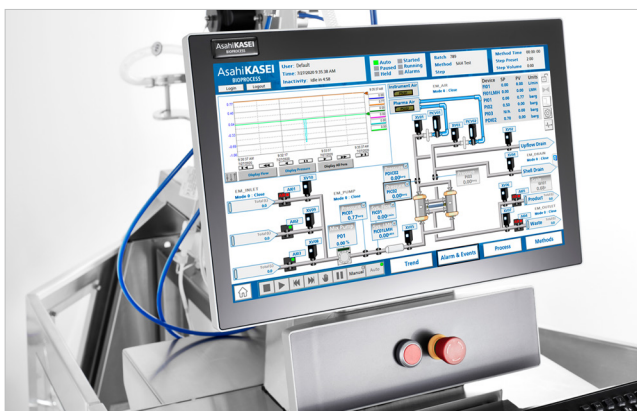

Presets can be saved from the process control screen for later use in the method.

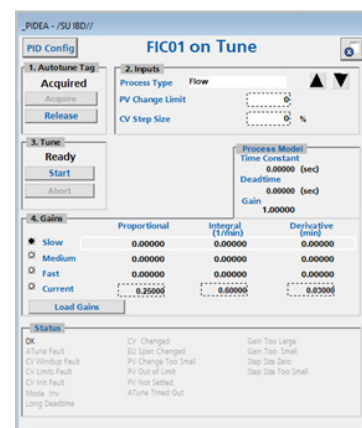

Autotuning simplifies control and ensures robust and repeatable processing.

Streamlined Integrity Testing

The Visual Leak Test (VLT) at a 10° tilt can be performed both pre-use and post-use* to confirm the absence of pinholes and other membrane damage. With shell side filled with purified water and hollow fibers pressurized, the filter is observed for the lack of continuous bubbling.

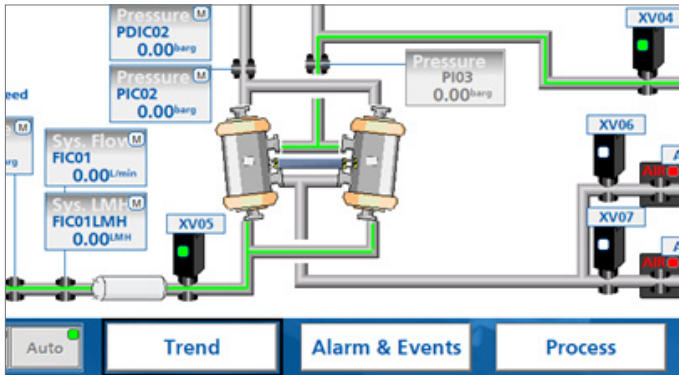

The 10° tilt verifies lack of continuous bubbling.

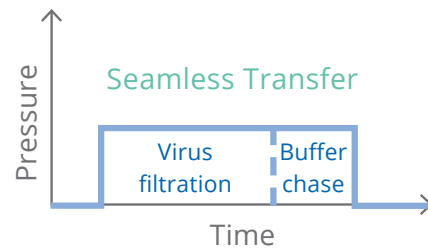

Figure 1. Transfer seamlessly between product and buffer chase, eliminating the pause between product filtration and buffer chase.

Automation of the pressurization step has **major benefits:**

- » Pressurize filter to correct level without risk of over pressurization
- » Repeatability – conducted the same EVERY time, independent of operator
- » Mandatory step cannot be skipped
- » Traceability as pressurization data and operator Pass/Fail determination is captured in secure batch record

Our automation is built to your specifications and will work with existing plant-wide systems.



Reliable Planova filtration for trusted repeatability.

* Post-use gold particle test (GPT) is also required for Planova™ 15N, 20N and 35N filters.

How Planova™ SU-VFC Works

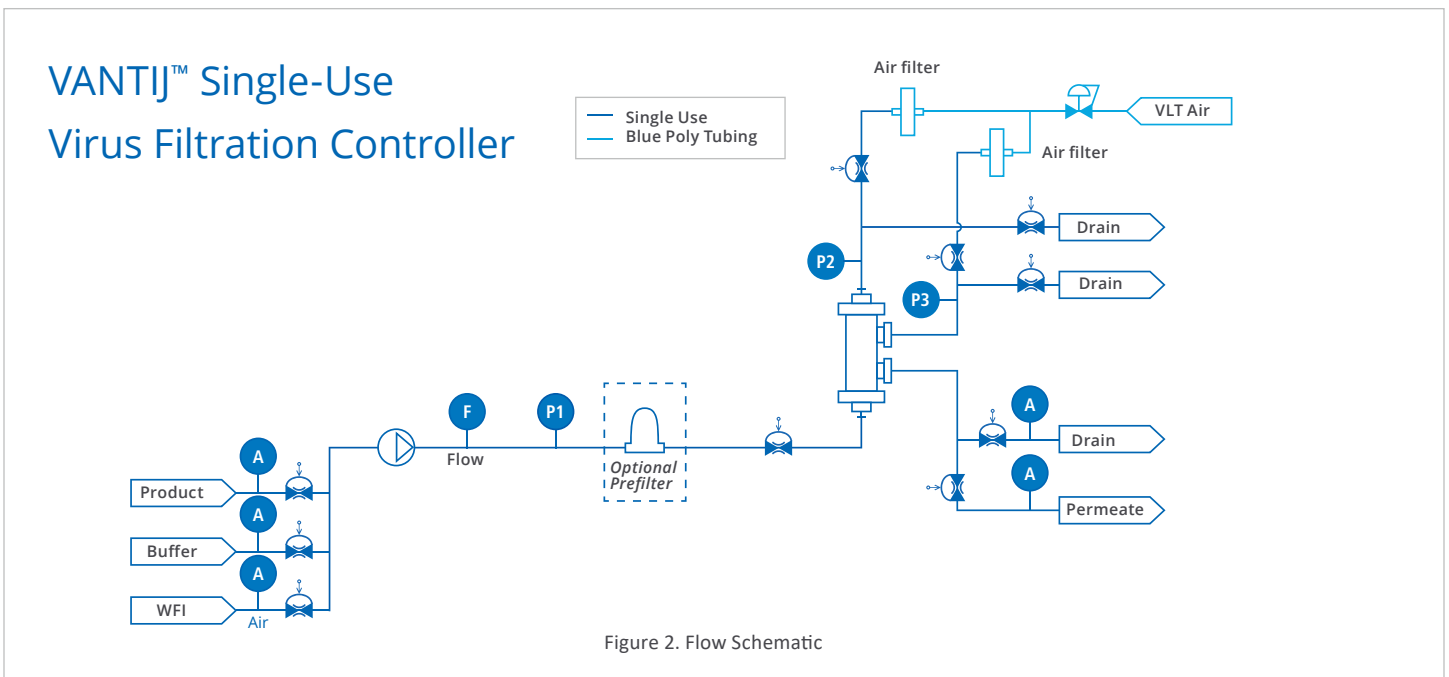

Product Features

- » Dimensions: modest 610 mm (24 in.) x 1219 mm (48 in.) x 1931 mm (76 in.)
- » Operating system flow rate: 0.08 to 10.00 L/min
- » Maximum operating pressure: 4.0 barg at 40° C
- » Universal, gamma-irradiated tube set
- » C-Flex® thermoplastic elastomer (TPE) tubing; braided and unbraided
- » Connections: Three (3) inlets and four (4) outlets
- » Product feed: By onboard single-use diaphragm pump
- » Control method: Filter differential pressure control or flow rate control
- » Operator interface: Local touchscreen display
- » Software compliance: 21 CFR Part 11 compliant
- » Qualifications: IQ/OQ package
- » EU Declaration of Conformity (for European markets) available



Product Ordering and Support Services

Operating Ranges

The Planova™ SU-VFC is designed for the following filters:

Filter Type	Number	Effective Surface Area
Planova 15N, 20N	1 or 2	1.0 m ²
	1 or 2	4.0 m ²
Planova 35, BioEX	1 or 2	1.0 m ²
	1	4.0 m ²

Ordering information

Catalog No.	Product Description
VFC108	Planova SU-VFC
TS-SUVF-311	1 x 1.0 m ² SUVF Tubing Set Kit
TS-SUVF-321	2 x 1.0 m ² SUVF Tubing Set Kit
TS-SUVF-314	1 x 4.0 m ² SUVF Tubing Set Kit
TS-SUVF-324	2 x 4.0 m ² SUVF Tubing Set Kit
VFC112	SU-VFC IQ/OQ package
SRV302	GMP system documentation package
SRV108	Crating and shipping, DAP continental US

Note: This product may be subject to export control

Technical Client Services

Technical Client Services (TCS), is a customer-centric interface to our product and science experts. Our TCS team will guide your process and engineering needs as your personal liaison for inquiries.

Contact us to learn more about how TCS can support your virus filtration and downstream processing equipment needs.

Asahi Kasei Bioprocess America, Inc.

Technical Client Services

+1 833-HLP-AKBA (457-2522)

TCS.support@ak-bio.com

www.ak-bio.com

Technical Support Network

A reliable technical support network is available throughout North and South America, Europe and Asia.

Warranty

We offer an extendable 1-year warranty, service contracts and a personalized level of service for peace of mind and timely support when you need it.

REQUEST A QUOTE >

Global Offices

North and South America

Glenview, IL, USA
Tel: +1-833-457-2522
Fax: +1-847-556-9701

Email: info.us@ak-bio.com

Europe

Cologne, Germany
Tel: +49-221-995007-59
Fax: +49-221-9950077-59

Email: info.eu@ak-bio.com

India and Southeast Asia

Mumbai, India
Tel: +91-22-6710-3962
Fax: +91-22-6710-3979

Email: info.jp@ak-bio.com

East Asia and Oceania

Glenview, IL, USA
Tel: +1-833-457-2522
Fax: +1-847-556-9701

Email: info.jp@ak-bio.com

China

Shanghai, China
Tel: +86-(0)21-6391-6111
Fax: +86-(0)21-6391-6686

Email: info.jp@ak-bio.com